

**TWO DIVER SCUBA REPLACEMENT PACKAGE (SRP) WITH CARBON COMPOSITE CYLINDERS**  
# SY-2DAP-D040-CSRP-X-XXX



**PART NO : SY-SRP-2DAP-D040-CSRP-X-XXX**

**Design**

- All Stainless Steel 316 construction, four diagonal lifting points with ringed pad eyes and fork lift slots.
- Dedicated lifting slings, certified, provided with SRP
- 4 X 50 LTR X 200 BAR Carbon Composite cylinders, light weight
- State of the art dive panels, fully engraved, color coded per diver, built into a waterproof, dust proof, unbreakable Pelican case
- Built to utilize 2 x 100 mtr / 150 mtr / 200 mtr diving umbilicals.
- Various options – Inbuilt radio, inbuilt CCTV systems for diver 1, diver 2, battery pack to run the video systems
- High pressure air hoses with ss fittings from cylinders to dive panel
- Bespoke panels can also be supplied, with client company logo, asset number etc printed on the system
- The system is supplied with complete certification package as per IMCA guidelines and class witness certification

**DESIGN for Mobile/Portable Surface Supplied Systems IMCA D040**



**TWO DIVER SCUBA REPLACEMENT PACKAGE (SRP) WITH CARBON COMPOSITE CYLINDERS**  
# SY-2DAP-D040-CSRP-X-XXX



**Bespoke designs : The panel colors and client logo can be made to choice**

**TWO DIVER SCUBA REPLACEMENT PACKAGE (SRP) WITH CARBON COMPOSITE CYLINDERS**  
**# SY-2DAP-D040-CSRP-X-XXX**



**TECHNICAL DATA SHEET:**

**Frame Dimensions**

Umbilical Hook	55 cm (550mm)
Construction	316 Stainless Steel (mirror finish)
SRP complete unit	1950mm (L) x 1700mm (H) x 1350mm (W)
Ringed Pad Eye	100mm (H) x 100mm(W) x 30mm (with ring)
Pad eye design	DNV 2.7-1

**Optional Extras**

Wheels	Bolted wheels for easy transport
DC power	Battery pack 12v complete with fast charger in water proof junction box and battery leads

**TWO DIVER PORTABLE PANEL - SY-2DAP-D040-X-XXX**



**PART NO : SY-2DAPD040-R-2DV**

Two diver panel with radio and diver 1 / diver 2 cctv system

**TWO DIVER PORTABLE PANEL - SY-2DAP-D040-X-XXX**



**PART NO : SY-2DAPD040-R-1DV**

Two diver panel with radio and diver 1 cctv system

**BESPOKE DESIGNS TO SUIT EVERY CLIENT REQUIREMENT**



**PART NO : SY-2DAP-HSE-INSHORE**  
Two diver panel inshore



**PART NO : SY-2DAP-D040**  
Two diver panel offshore



**PART NO : SY-2DAP-D040-R**  
Two diver panel with radio



**PART NO : SY-2DAP-D040-R-1DV**  
Two diver panel with radio and diver 1 cctv



**PART NO : SY-2DAP-D040-R-2DV**  
Two diver panel with radio and diver 1, diver 2 cctv

**TWO DIVER PORTABLE PANEL - SY-2DAPD040-X-XXX**

DIVING PANEL WITH RIGHT SIDE (DIVER 1) AND LEFT SIDE (DIVER 2) INLET AND OUTLET FITTINGS

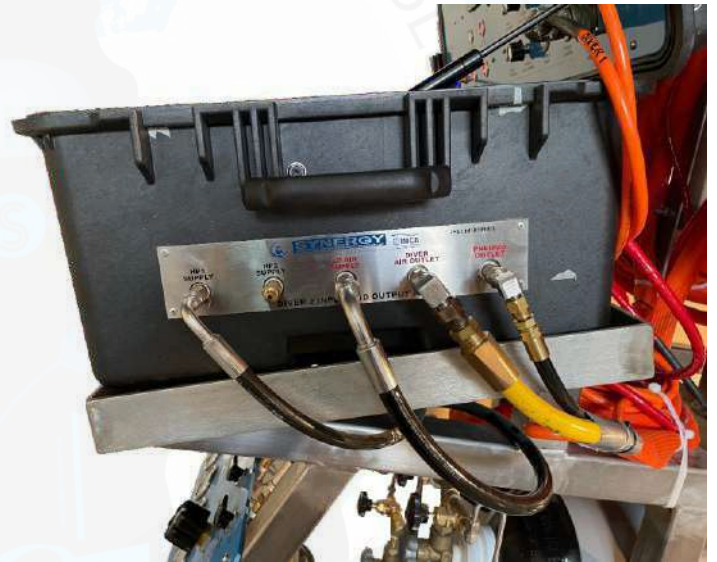

DIVING PANEL WITH DIVER 1 AND DIVER 2 INLET AND OUTLET FITTINGS FROM THE BACKSIDE OF THE PANEL



## TWO DIVER PORTABLE PANEL - SY-2DAPD040-X-XXX

### Information Two Diver Panel

Case	Model 1650, Black, Interior (28.57" L x 17.52" W x 10.65" H), with wheels and handle, water, rust and dust proof), Pelican USA Exterior dimensions: 80.14 x 52.1 x 31.67cm (31.55" x 20.51" x 12.47") Interior dimensions: 72.16 x 44.2 x 27.03cm (28.41" x 17.40" x 10.64") Weight without foam: 10.9kg (24.03lbs)
------	--

1 x 0-160 fsw/50 msw Depth gauge, 4.5", 0.25 % accuracy, mirror scale, with calibration point, Diver 1, Color coded Blue
--

1 x 0-160 fsw/50 msw Depth gauge, 4.5", 0.25 % accuracy, mirror scale, with calibration point, Diver 2, Color coded Red
---

Air Supplies	HP - 3 independent supplies, one per diver, LP - 3 independent supplies, one per diver
Communication	Amron 2820A-11 Two diver radio with ac/dc power supply
Regulator	1 x per diver, suitable for breathing air, Inlet : 6000 psi, outlet : 400 psi
Relief valves	0-250 psi on regulated diver supply line, 100 psi on pneumo gauges

### Air supply ports:

Option 1	All fittings provided on both sides of case – Left side all inlet fittings for hp air, lp air, right side divers air supply and pneumo fittings.
Option 2	All fittings provided from behind the panel for inlets and outlets
Calibration	Inbuilt calibration points for pneumo gauges

### Optional :

CCTV	Can be provided for both diver 1 and diver 2
Monitor	TFT 15.5" (splitter will be provided if both diver CCTV options are required)
Surface control unit	All touch button controls with backlight for low visibility operations, video and light control
Primary recording	1 TB hard drive to record all diver video simultaneously
Secondary backup recording	1 TB backup hard drive to record all diver video simultaneously



**TWO DIVER SCUBA REPLACEMENT PACKAGE (SRP) WITH CARBON COMPOSITE CYLINDERS**  
**# SY-2DAP-D040-CSR-P-X-XXX**

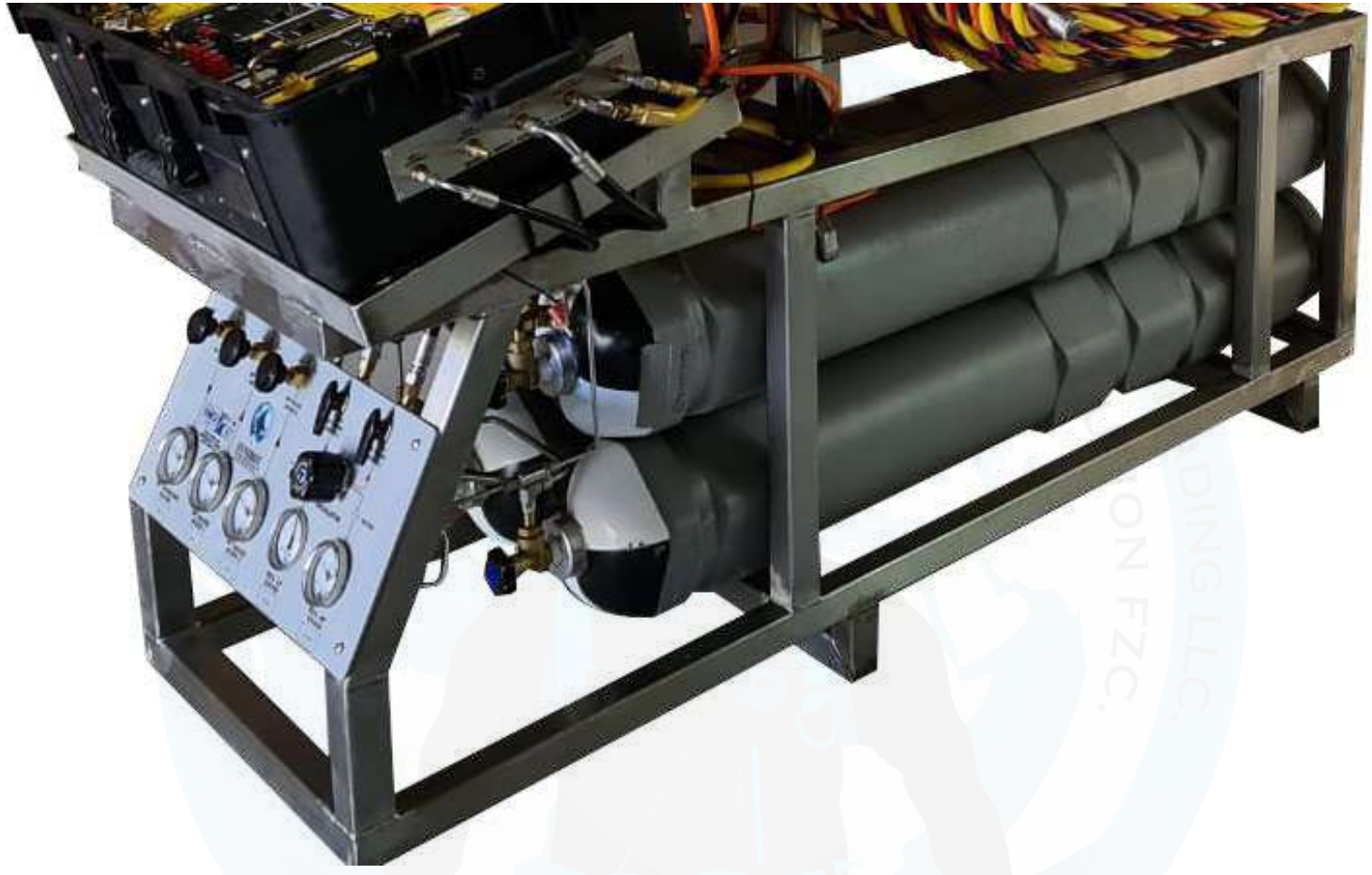

Information	Emergency Panel
Cylinder Charging	HP charging valve/Gauge
Regulator	High Pressure regulator, inlet 6000 psi Outlet 400 psi
Supplies to Dive Panel	D1/D2 HP valves/Gauges
Regulated Supply	D1/D2 LP valves/Gauges
Connections	Valves/fittings/piping from cylinders to panel

**TWO DIVER SCUBA REPLACEMENT PACKAGE (SRP) WITH CARBON COMPOSITE CYLINDERS**  
**# SY-2DAP-D040-CSRP-X-XXX**



**SYNERGY COMPOSITE CYLINDER is unique in the gas distribution business. Not only do we sell gas, but we also sell innovation and high technology.**

Since gas distribution commenced, with liquefied air gases, there have been very few significant changes in the way in which the product is presented to clients. The cylinder entails a revolution in the sector and the democratisation of high technology. This is because the investment cost now makes mass distribution possible to end clients purchasing carbon fibre cylinders, regardless of their sector, industrial, food or pharmaceutical.

## TWO DIVER SCUBA REPLACEMENT PACKAGE (SRP) WITH CARBON COMPOSITE CYLINDERS # SY-2DAP-D040-CSRP-X-XXX

### Description

This lightweight smart cylinder is available in three standard sizes, with 13.3, 20 and 50 litre capacities. It is wholly designed and manufactured in Spain and provides an innovative and absolutely revolutionary solution for the high pressure gas cylinders market.

Its special patented design lets it be packaged in a completely secure manner on standard pallets. This eliminates the need to use steel cages, which considerably simplifies transport and, indeed, represents a revolution in current distribution models. It includes an RFID chip that lets purchase orders be generated totally automatically, as well as real-time traceability controls and access to all information on the cylinder at any time, from the start of the manufacturing process through its final application.

The next generation lightweight materials employed to produce it, such as high-performance carbon fibre and thermoplastic polymers with UV protection, ensure that its weight barely exceeds one-third the weight of conventional steel cylinders, although our cylinder maintains its great mechanical and chemical resistance. It also has an aluminium alloy liner subjected to our exclusive in-house thermal treatment, which gives it high elasticity and resistance to fatigue cycles, despite its thinness, which gives the cylinder a 30 year lifecycle, as well as full aptitude for food, medicinal and pharmaceutical uses.



### Regulations

The cylinders produced comply with the most demanding quality and security standards. They also hold product certification from AENOR under European Standard EN12245, Directive 2035/10/EU (TPED) and International Standard ISO 11119-2.

### Applications

This innovative cylinder was designed especially for containing the most common industrial gases, both in mix and in their pure state:

- Oxygen (O2)
- Nitrogen (N2)
- Hydrogen (H2)
- Argon (Ar)
- Helium (He)
- Carbon dioxide (Co2)
- Compressed Carbon monoxide (CO)
- Hydrogen Sulphide (H2O)
- Nitrogen Oxide (N2O)
- Sulphure dioxide (So2)



**ACCESSORIES**

**12V 75 AMPS CAR BATTERY WITH FAST BATTERY CHARGER IN WATER PROOF JUNCTION BOX PROVIDED WITH SRP**



**PART NO : SY-SRP-2DAP-D040-CSRP-X-XXX**

## SYNERGY SURFACE DIVING HOSES AND UMBILICALS SY-AQUAFLOW

Known worldwide for its lightweight and ultra flexible construction, Aquaflow hoses are ideal for surface demand applications. Aquaflow kink resistant construction comprises of an extruded core tube, reinforcement of high strength yarn and a bonded outer cover. Both tube and cover are extruded from high performance thermoplastic polymers which are particularly clean and free from odors often associated with conventional rubber hoses. Coupled with the wide operating temperature range this ensures breathing gas quality is maintained under all conditions from -20°C to +66°C.

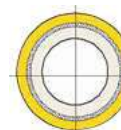

Part No.	Nominal Bore		O.D.		Min. bend radius		Working pressure		Nom. burst pressure		Weight in air		Weight in sea water		Typical application
	in	mm	in	mm	in	mm	psi	bar	psi	bar	lb/ft	g/m	lb/ft	g/m	
SY-HDA0104	1/4	6.3	0.50	12.7	1.25	32	300	21	1200	84	0.078	116	-0.009	-14	Pneumo
SY-HDA0106	3/8	9.5	0.66	16.8	2	50	500	35	2000	140	0.119	177	-0.034	-50	Air/Gas
SY-HDA1108	1/2	12.7	0.83	21.0	3	76	300	25	1200	84	0.178	265	-0.054	-80	Hot water

### Aquaflow Umbilicals



Lightweight, ultra flexible and kink resistant, Aquaflow Umbilicals are ideal for breathing gas supply, comms and pneumo service for surface demand umbilicals. They can be produced in production runs up to 740 meters long and can be over extruded or braided for additional protection against abrasion and use in contaminated waters.

The unique materials and cabled "rope-like" construction combine to produce the most flexible, controlled buoyancy umbilicals available today. The umbilicals have no need

for tape, the repairs are much reduced and they have a longer life. They keep the professional diver safer and more efficient both while diving and on deck. They will ultimately reduce costs for the operator. The highest quality materials, workmanship with competitive pricing and unmatched service to our clients worldwide. SYNERGY invites you to visit our website or contact us directly so that we can assist you with all your Diving Umbilical needs.

## SYNERGY SURFACE DIVING HOSES AND UMBILICALS SY-AQUAFLOW

### SY-UDA0103

3 part surface demand



### SY-UDA0204

3 part plus video



**SYNERGY SURFACE DIVING HOSES AND UMBILICALS SY-AQUAFLOW**



**Diving Umbilical with protective outer sheet**



**Diving Umbilical with spiral wrap**



**Diving Umbilical without protective outer sheet**

## OUTLAND VIDEO CAMERA / LIGHTS / UMBILICALS

Mechanical	Specification
Weight	6 oz (.2kg) Dry, 3 oz(.06kg) wet
Depth Rating	2000 ft (600m)
Housing	Black delrin
Electrical	
Image Device	1/3" CCD sensor (412k pixel)
Sensitivity	.001 lux @f1.4
Resolution	600 TV lines standard
Video Out	1.2 Vpp
Power	12 VDC @ 110 ma.
Optical	
Lens	3.6mm, Electronic-Iris
Focus	Fixed 4" to infinity
Angle of View	70 horz. (in water)



PART NO : SY-UWC-325/p/e



PART NO : SY-UWL-401

Mechanical	Specification
Weight	7oz(0.2kg) Dry, 3 oz.(.1kg) Wet
Depth Rating	2000 ft (600m)
Housing	6061-16 Anodized Aluminium
Electrical	
Power	12 VDC @ 110 ma.
Wattage	18 watt (Eq to 150 watt halogen)
Output	700 lux at 1 meter

Mechanical	Specification
Conductors	16ea #22 awg 1 RG-59 Coax
Length (mtrs)	100/150/200 as per requirement
Diameter	8.5mm (0.35")
Materials	Orange Polyurethane jacket
Breaking Strength	1200 lbs
End fittings	
Diver End	Moulded Y connection
Camera	Rmk-5-fs with locking sleeve
Light	Rmg-3-fs with locking sleeve
Surface end	Soldered connection
Cable	8 pin amphenol connector



PART NO : SY-VC-150M

## SY-2820A-11 AMCOM II TWO-DIVER RECHARGEABLE BASIC PORTABLE COMMUNICATOR



### NEWLY DESIGNED ENHANCEMENTS:

#### High Audio Fidelity

Ultra-low noise circuit combined with noise suppression circuitry produces crystal clear speech. Automatic gain adjustment

will guard audio signal from distortion, enhance speaker protection and audio quality. Increases band width 47%.

#### Extended Battery Operation Time

Audio amplifier card deploys the state-of-the-art Class-D digital audio power amplifier. Has very low power dissipation, produces less heat, and extends battery life up to 32%.

#### Flexible Gain Settings

The audio amplifier card has adjustable gain settings to accommodate different communication applications and environments.

#### Ultra-Low Electromagnetic Interference (EMI)

EMI is achieved through spread-spectrum and de-phase control techniques providing for optimum integration with diving systems.

#### Outdoor Rated AC Power Module

Weather resistant, IP65 rated AC power entry module accommodates country specific AC power cords.

#### Country Specific V-Lock AC Power Cord

At time of order, simply choose the IP54 rated Locking AC power cord you need.

### FEATURES:

- Single volume control for both divers.
- Diver's umbilicals can be set up on 4-wire mode (full duplex) or 2-wire mode (push-to-talk) or any combination of the two modes for each diver.
- Ability to use both dynamic and pre-amplified diver microphones with a unique circuit that detects microphone type and automatically adjusts volume levels.
- The divers' connections consist of cross-talk and separate speaker and microphone inputs.
- Internal charger allows for simultaneous charging and operation of the unit while protecting the rechargeable battery from being over-charged. Automatically supplies power to the audio amplifier when AC power is disconnected to allow for continued operation.
- See Tech Note (below) for recommended accessories.



## SY-2820A-11 AMCOM II TWO-DIVER RECHARGEABLE BASIC PORTABLE COMMUNICATOR

### SPECIFICATIONS:

- Input Impedance (Each Input): 250 Ohms
- Frequency Response: 300 - 10000 Hz
- Common Mode Rejection: 40 dB Minimum
- Current Drain Maximum Full Volume: 3 Amps
- Minimum Quiescent: 0.190 Amps
- Output Impedance: 4 Ohm
- Power Supply Voltage: 12 VDC Nominal (9 Volts Minimum - 16 Volts Maximum)
- AC Power Operating Range: 90-264 VAC, 50-60 Hz
- Sensitivity (Input): 0.5 mV
- Output Power (RMS @ 4 Ohm Load, 12 VDC): 10 Watts Audio
- Battery Life: 45 hours
- Dimensions: 10 in. H x 9 in. W x 14.5 in. L (25.4 cm x 22.9 cm x 36.8 cm)
- Weight: 16.25 Lbs. (7.37 Kg)

### INCLUDED WITH COMMUNICATOR:

SY-2820A-11AMCOM II Two-Diver Rechargeable Basic Portable Communicator with Outdoor Power Module and International Locking Power Cord includes:

- (1) SY-2890-05 Amron 12 VDC Sealed Lead Acid Gel-Cell Rechargeable Battery with Slide terminals
- (1) SY-282XA-UM Amron Two Diver Portable Communicator User Manual

### AVAILABLE OPTIONS:

- SY-2460SM-28 Amron Single Muff Operator Headset with Boom Mic and Dual Banana Plugs
- SY-2405-28 Amron Hand-Held Push-to-Talk Microphone
- SY-2401-28 Amron Deluxe Headset with Boom Mic
- SY-2460-28 Amron Standard Headset with Boom Mic
- SY-2822-28 Amron Remote Walk-and-Talk (4-wire mode)
- SY-2821-28 Amron Remote Walk-and-Talk (2-wire mode)

### TECH NOTE:

All communicators will inherently transfer topside noise to the divers when the tender speaks directly into the communicator's panel speaker. To eliminate background noise at the surface, we recommend purchasing the 2405-28 Push-to-Talk Microphone (not included with this model). For optimum communications, it is recommended to use the 2401-28 Deluxe Headset with Boom Mic, topside. For tender maneuverability, use the 2401-28 Deluxe Headset with Boom Mic along with the 2822-28 Remote Walk-and-Talk (4-wire mode) or the 2821-28 Remote Walk-and-Talk (2-wire mode). For wireless tender communications, order the 2825A-03 Two Diver Deluxe Portable Communicator with built-in Wireless Tender option.

## SYNERGY PIGTAILS AND CONNECTORS

Connector	SY-RMK-5-FS
Type	5 Female Sockets
Cable	18 in Pigtail of 18 SO AWG Cable
Material	Special Neoprene, Molded
Contacts	Copper Alloy, Hard Gold Plated per ASTM-B-488
Voltage Rating	600 VDC
Pressure Rating, Mated	Up to 20,000 psi
Mates with	SY-XSL-5-BCL on Outland Camera SY-UWC-325/p/e

**PART NO : SY-RMK-5-FS**



**PART NO : SY-RMG-3FS**



Locking sleeve for Rmg-3-fs

**PART NO : SY-G-FLS-D**



Locking sleeve for Rmk-5-fs

**PART NO : SY-K-FLS-D**

Connector	SY-RMG-3-FS
Type	3 Female Sockets
Cable	18 in Pigtail of 18 SO AWG Cable
Material	Special Neoprene, Molded
Contacts	Copper Alloy, Hard Gold Plated per SY-ASTM-B-488
Voltage Rating	600 VDC
Pressure Rating, Mated	Up to 20,000 psi
Mates with	SY-XSG-3-BCL on Outland light SY-UWL-401

**PART NO : SY-MS3108B-18-08P**



<b>Certifications</b>	Provided with each system
International	IMCA D023
Manufacturer	Synergy Certificates
Electrical	Continuity/Function test



**PART NO : SY-CLBRK**

SS camera and light bracket with jubilee clamp

Cannon Right Angle Amphenol Connector is used for connecting the video camera umbilical to the surface video console unit.



## TWO DIVER SCUBA REPLACEMENT PACKAGE (SRP) WITH CARBON COMPOSITE CYLINDERS # SY-2DAP-D040-CSRP-X-XXX

### ORDERING INFORMATION

Sr.	Part Number	Description
1	SY-2DAP-D040-CSRP-X-XXX	Two diver scuba replacement panel with ss frame, emergency panel, 4 x 50 ltr x 200 bar breathing air light weight carbon composite cylinders, all plumbing with fittings, valves, hoses to connect from cylinders to diving panel (diving panel not included, please choose from panel options below)

Sr.	Part Number	Description
1	SY-2DAP-INSHORE-SF	Portable two diver panel, inshore use only, side inlet and outlet fittings
2	SY-2DAP-INSHORE-BF	Portable two diver panel, inshore use only, back inlet and outlet fittings
3	SY-2DAP-D040-SF	Portable two diver panel, offshore, imca (no radio, no diver cctv), side inlet and outlet fittings
4	SY-2DAP-D040-BF	Portable two diver panel, offshore, imca (no radio, no diver cctv), back inlet and outlet fittings
5	SY-2DAP-D040-R-SF	Portable two diver panel, offshore, imca with radio (no diver cctv), side inlet and outlet fittings
6	SY-2DAP-D040-R-BF	Portable two diver panel, offshore, imca with radio (no diver cctv), back inlet and outlet fittings
7	SY-2DAP-D040-R-1DV-SF	Portable two diver panel, offshore, imca with radio and diver 1 cctv, side inlet and outlet fittings
8	SY-2DAP-D040-R-1DV-BF	Portable two diver panel, offshore, imca with radio and diver 1 cctv, back inlet and outlet fittings
9	SY-2DAP-D040-R-2DV-SF	Portable two diver panel, offshore, imca with radio and diver 1 and diver 2 cctv, side inlet and outlet fittings
10	SY-2DAP-D040-R-2DV-BF	Portable two diver panel, offshore, imca with radio and diver 1 and diver 2 cctv, back inlet and outlet fittings



Sr.	Part Number	Description
1	SY-2820A-11	Amcom ii two-diver rechargeable basic portable communicator
2	SY-UDA-0204	4 core Umbilical air/gas, pneumo, communication and video cables
3	SY-UDA-0103	3 core Umbilical air/gas, pneumo, communication
4	SY-ORANGESHEATH	Full braided protective outer sheath (for complete protection of umbilicals)
5	SY-SPIRAL WRAP	Spiral wrap (in 10 mtr lengths) (for umbilical protection)
	<b>Fittings as below</b>	
6	SY-386-PB-AIR	3/8"x 6 jic phosphor bronze reusable umbilical air/gas hose end fitting
7	SY-144-PB-PNEUMO	1/4" x 4 jic phosphor bronze reusable umbilical pneumo end fitting
8	SY-RMG-3-FS	Marsh marine, 3 pin, Female, 18"
9	SY-BANPLUGS-TWIN	Twin banana plugs surface communication end fitting (Red/Black)
10	SY-RMK-5-FS	Marsh marine, 5 pin, female, 18"
11	SY-K-FLS-D	Locking sleeve, delrin, for RMK-5-FS
12	SY-RMG-3-FS	Marsh marine, 3 pin, female, 18"
13	SY-G-FLS-D	Locking sleeve, delrin, for RMG-3-FS
14	SY- MS3108B-18-08P	Cannon right angle amphenol connector is used for connecting the Surface end of the video camera umbilical to the surface video console unit

**TWO DIVER SCUBA REPLACEMENT PACKAGE (SRP) WITH CARBON COMPOSITE CYLINDERS**  
**# SY-2DAP-D040-CSRP-X-XXX**

# Contact us

 29th Street, Amman Road, Behind Al Huraiz Est. For Industry,  
Al Qusais, Industrial Area – 1,  
Dubai, United Arab Emirates

-  Tel : 009714 2580533 
-  Fax : 042516664 
-  UAE : 00971505648178 
-  UK : 00447951966260 

-  Website : [www.synergyequipment.com](http://www.synergyequipment.com)
-  Email : [ram@synergyequipment.com](mailto:ram@synergyequipment.com)
-  For Sale : [info@synergyequipment.com](mailto:info@synergyequipment.com)

